

IRGB4045DPbF

INSULATED GATE BIPOLAR TRANSISTOR WITH ULTRAFAST SOFT RECOVERY DIODE

Features

- Low $V_{CE(on)}$ Trench IGBT Technology
- Low Switching Losses
- Maximum Junction temperature 175 °C
- 5 μ s SCSOA
- Square RBSOA
- 100% of the Parts Tested for I_{LM}
- Positive $V_{CE(on)}$ Temperature Coefficient.
- Ultra Fast Soft Recovery Co-pak Diode
- Tighter Distribution of Parameters
- Lead-Free Package

Benefits

- High Efficiency in a Wide Range of Applications
- Suitable for a Wide Range of Switching Frequencies due to Low $V_{CE(ON)}$ and Low Switching Losses
- Rugged Transient Performance for Increased Reliability
- Excellent Current Sharing in Parallel Operation
- Low EMI

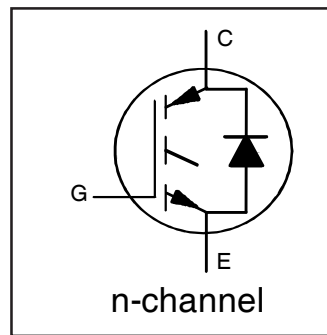

$V_{CES} = 600V$
$I_C = 6.0A, T_C = 100^\circ C$
$t_{sc} > 5\mu s, T_{jmax} = 175^\circ C$
$V_{CE(on) typ.} = 1.7V$

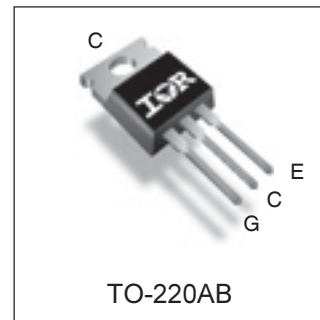

G	C	E
Gate	Collector	Emitter

Absolute Maximum Ratings

	Parameter	Max.	Units
V_{CES}	Collector-to-Emitter Breakdown Voltage	600	V
$I_C @ T_C = 25^\circ C$	Continuous Collector Current	12	A
$I_C @ T_C = 100^\circ C$	Continuous Collector Current	6.0	
I_{CM}	Pulsed Collector Current	20	
I_{LM}	Clamped Inductive Load Current ①	20	
$I_F @ T_C = 25^\circ C$	Diode Continuous Forward Current	8.0	
$I_F @ T_C = 100^\circ C$	Diode Continuous Forward Current	4.0	
I_{FM}	Diode Maximum Forward Current ②	20	
V_{GE}	Continuous Gate-to-Emitter Voltage	± 20	V
	Transient Gate-to-Emitter Voltage	± 30	
$P_D @ T_C = 25^\circ$	Maximum Power Dissipation	77	W
	$P_D @ T_C = 100^\circ$	Maximum Power Dissipation	
T_J T_{STG}	Operating Junction and Storage Temperature Range	-55 to + 175	°C
	Soldering Temperature, for 10 seconds	300 (0.063 in. (1.6mm) from case)	

Thermal Resistance

	Parameter	Min.	Typ.	Max.	Units
$R_{\theta JC}$	Junction-to-Case - IGBT ③	—	—	1.94	°C/W
$R_{\theta JC}$	Junction-to-Case - Diode ③	—	—	6.30	
$R_{\theta CS}$	Case-to-Sink, flat, greased surface	—	0.5	—	
$R_{\theta JA}$	Junction-to-Ambient, typical socket mount ③	—	—	62	

Electrical Characteristics @ $T_J = 25^\circ\text{C}$ (unless otherwise specified)

	Parameter	Min.	Typ.	Max.	Units	Conditions	Ref.Fig
$V_{(BR)CES}$	Collector-to-Emitter Breakdown Voltage	600	—	—	V	$V_{GE} = 0V, I_C = 100\mu\text{A}$ ④	CT6
$\Delta V_{(BR)CES}/\Delta T_J$	Temperature Coeff. of Breakdown Voltage	—	0.36	—	V/ $^\circ\text{C}$	$V_{GE} = 0V, I_C = 250\mu\text{A}$ (25 -175 $^\circ\text{C}$) ④	
$V_{CE(on)}$	Collector-to-Emitter Saturation Voltage	—	1.7	2.0	V	$I_C = 6.0A, V_{GE} = 15V, T_J = 25^\circ\text{C}$	5,6,7,9, 10,11
		—	2.07	—		$I_C = 6.0A, V_{GE} = 15V, T_J = 150^\circ\text{C}$	
		—	2.14	—		$I_C = 6.0A, V_{GE} = 15V, T_J = 175^\circ\text{C}$	
$V_{GE(th)}$	Gate Threshold Voltage	4.0	—	6.5	V	$V_{CE} = V_{GE}, I_C = 150\mu\text{A}$	9,10,11,12
$\Delta V_{GE(th)}/\Delta T_J$	Threshold Voltage temp. coefficient	—	-13	—	mV/ $^\circ\text{C}$	$V_{CE} = V_{GE}, I_C = 250\mu\text{A}$ (25 -175 $^\circ\text{C}$)	
gfe	Forward Transconductance	—	5.8	—	S	$V_{CE} = 25V, I_C = 6.0A, PW = 80\mu\text{s}$	
I_{CES}	Collector-to-Emitter Leakage Current	—	—	25	μA	$V_{GE} = 0V, V_{CE} = 600V$	8
		—	—	250		$V_{GE} = 0V, V_{CE} = 600V, T_J = 175^\circ\text{C}$	
V_{FM}	Diode Forward Voltage Drop	—	1.60	2.30	V	$I_F = 6.0A$	
		—	1.30	—		$I_F = 6.0A, T_J = 175^\circ\text{C}$	
I_{GES}	Gate-to-Emitter Leakage Current	—	—	± 100	nA	$V_{GE} = \pm 20V$	

Switching Characteristics @ $T_J = 25^\circ\text{C}$ (unless otherwise specified)

	Parameter	Min.	Typ.	Max.	Units	Conditions	Ref.Fig
Q_g	Total Gate Charge (turn-on)	—	13	19.5	nC	$I_C = 6.0A$ $V_{CC} = 400V$ $V_{GE} = 15V$	24
Q_{ge}	Gate-to-Emitter Charge (turn-on)	—	3.1	4.65			CT1
Q_{gc}	Gate-to-Collector Charge (turn-on)	—	6.4	9.6			
E_{on}	Turn-On Switching Loss	—	56	86	μJ	$I_C = 6.0A, V_{CC} = 400V, V_{GE} = 15V$ $R_G = 47\Omega, L = 1\text{mH}, L_S = 150\text{nH}, T_J = 25^\circ\text{C}$	CT4
E_{off}	Turn-Off Switching Loss	—	122	143			
E_{total}	Total Switching Loss	—	178	229			
$t_{d(on)}$	Turn-On delay time	—	27	35	ns	$I_C = 6.0A, V_{CC} = 400V$ $R_G = 47\Omega, L = 1\text{mH}, L_S = 150\text{nH}$ $T_J = 25^\circ\text{C}$	CT4
t_r	Rise time	—	11	15			
$t_{d(off)}$	Turn-Off delay time	—	75	93			
t_f	Fall time	—	17	22			
E_{on}	Turn-On Switching Loss	—	140	—			
E_{off}	Turn-Off Switching Loss	—	189	—			
E_{total}	Total Switching Loss	—	329	—	Energy losses include tail and diode reverse recovery		
$t_{d(on)}$	Turn-On delay time	—	26	—	ns	$I_C = 6.0A, V_{CC} = 400V$ $R_G = 47\Omega, L = 1\text{mH}, L_S = 150\text{nH}$ $T_J = 175^\circ\text{C}$	14,16 CT4 WF1,WF2
t_r	Rise time	—	12	—			
$t_{d(off)}$	Turn-Off delay time	—	95	—			
t_f	Fall time	—	32	—			
C_{ies}	Input Capacitance	—	350	—	pF	$V_{GE} = 0V$ $V_{CC} = 30V$ $f = 1\text{Mhz}$	23
C_{oes}	Output Capacitance	—	29	—			
C_{res}	Reverse Transfer Capacitance	—	10	—			
RBSOA	Reverse Bias Safe Operating Area	FULL SQUARE				$T_J = 175^\circ\text{C}, I_C = 20A$ $V_{CC} = 500V, V_p = 600V$ $R_G = 100\Omega, V_{GE} = +15V \text{ to } 0V$	4 CT2
SCSOA	Short Circuit Safe Operating Area	5	—	—	μs	$V_{CC} = 400V, V_p = 600V$ $R_G = 100\Omega, V_{GE} = +15V \text{ to } 0V$	22, CT3 WF4
E_{rec}	Reverse recovery energy of the diode	—	178	—	μJ	$T_J = 175^\circ\text{C}$	17,18,19
t_{rr}	Diode Reverse recovery time	—	74	—	ns	$V_{CC} = 400V, I_F = 6.0A$	20,21
I_{rr}	Peak Reverse Recovery Current	—	12	—	A	$V_{GE} = 15V, R_G = 47\Omega, L = 1\text{mH}, L_S = 150\text{nH}$	WF3

Notes:

- $V_{CC} = 80\%$ (V_{CES}), $V_{GE} = 15V$, $L = 1.0\text{mH}$, $R_G = 47\Omega$.
- Pulse width limited by max. junction temperature.
- R_θ is measured at T_J approximately 90°C .
- Refer to AN-1086 for guidelines for measuring $V_{(BR)CES}$ safely.

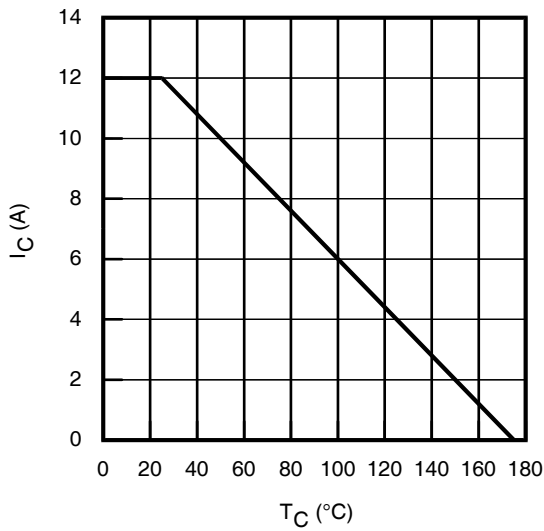

Fig. 1 - Maximum DC Collector Current vs. Case Temperature

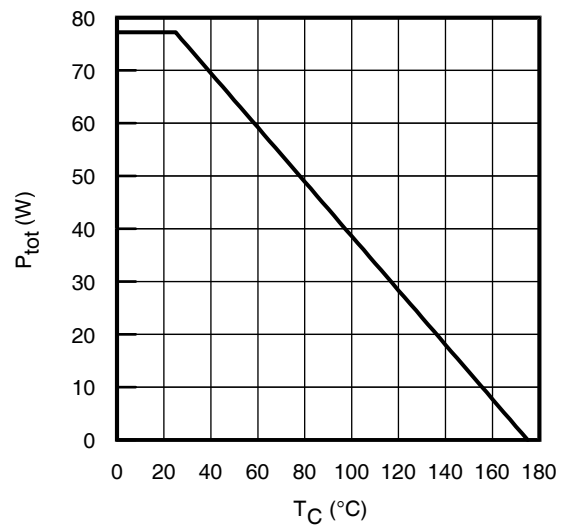

Fig. 2 - Power Dissipation vs. Case Temperature

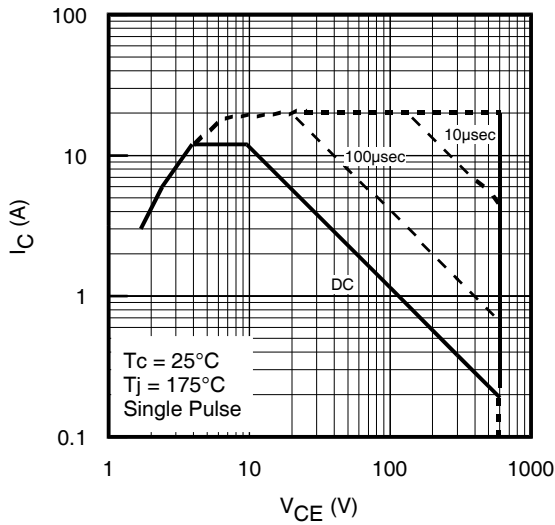

Fig. 3 - Forward SOA,
 $T_C = 25^{\circ}C$; $T_J \leq 175^{\circ}C$

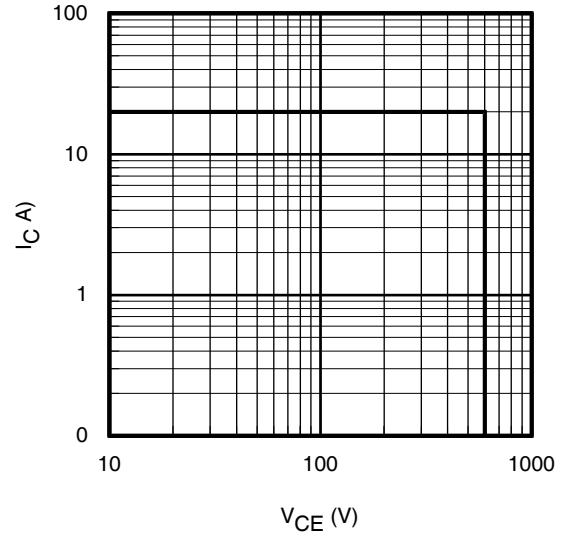

Fig. 4 - Reverse Bias SOA
 $T_J = 175^{\circ}C$; $V_{CE} = 15$ V

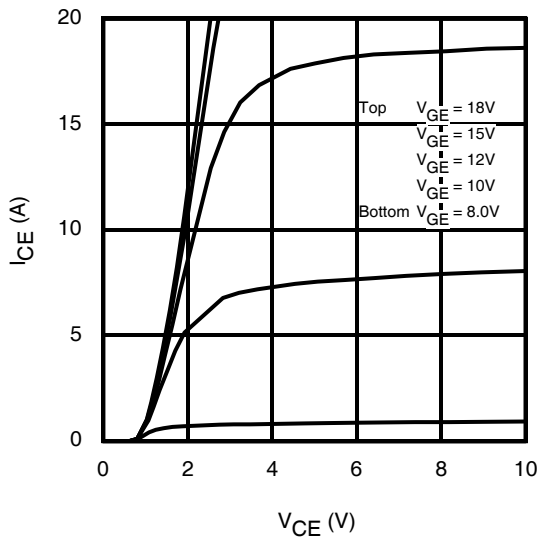

Fig. 5 - Typ. IGBT Output Characteristics
 $T_J = -40^{\circ}C$; $t_p = 80 \mu$ s

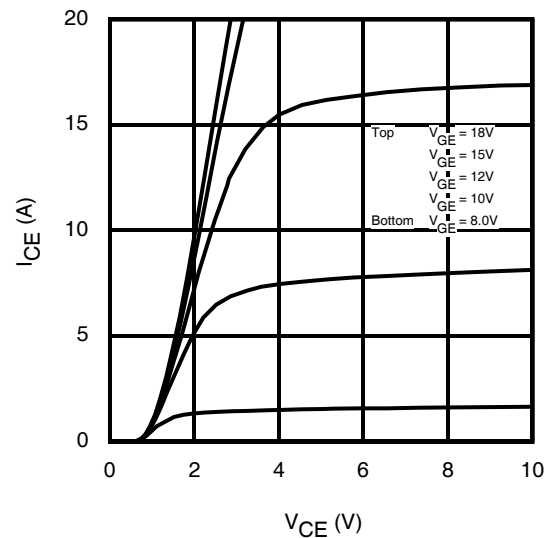

Fig. 6 - Typ. IGBT Output Characteristics
 $T_J = 25^{\circ}C$; $t_p = 80 \mu$ s

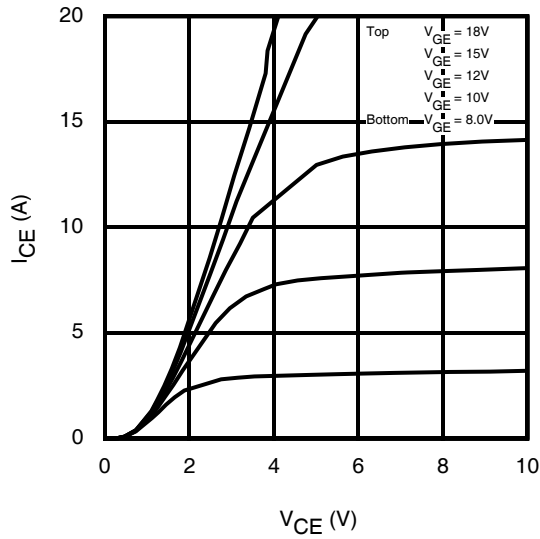

Fig. 7 - Typ. IGBT Output Characteristics
 $T_J = 175^\circ\text{C}$; $t_p = 80\mu\text{s}$

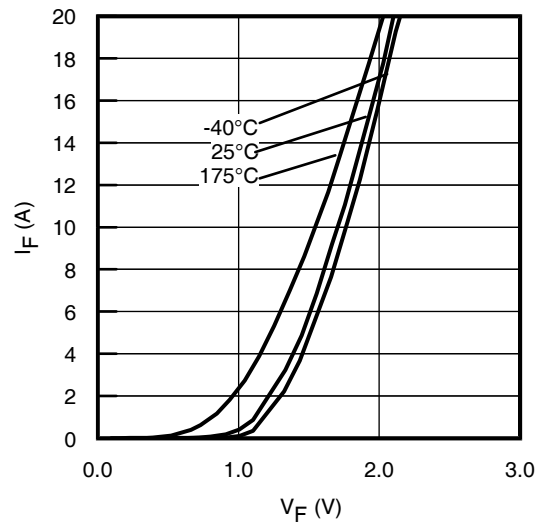

Fig. 8 - Typ. Diode Forward Characteristics
 $t_p = 80\mu\text{s}$

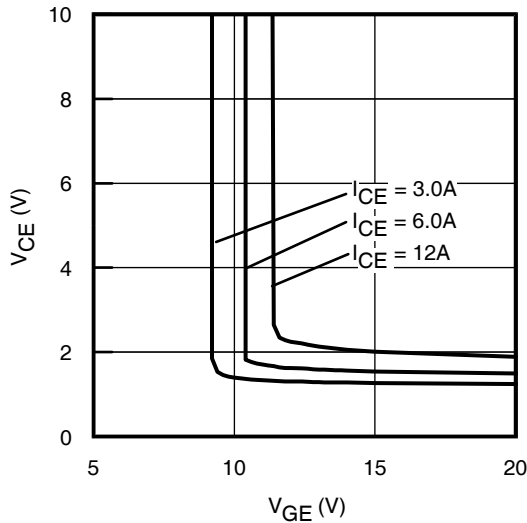

Fig. 9 - Typical V_{CE} vs. V_{GE}
 $T_J = -40^\circ\text{C}$

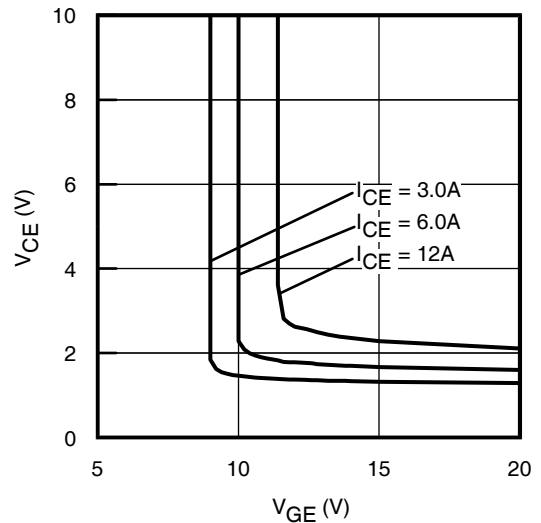

Fig. 10 - Typical V_{CE} vs. V_{GE}
 $T_J = 25^\circ\text{C}$

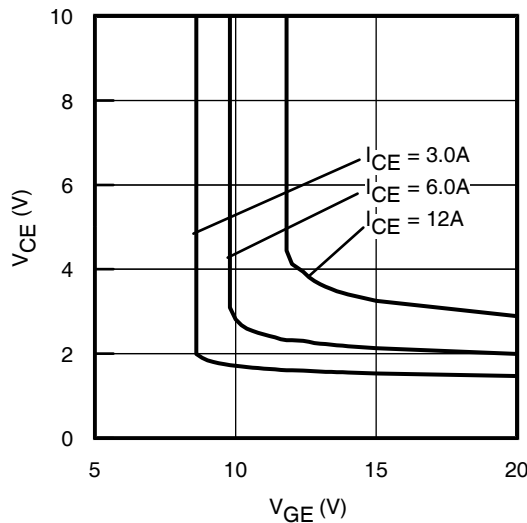

Fig. 11 - Typical V_{CE} vs. V_{GE}
 $T_J = 175^\circ\text{C}$

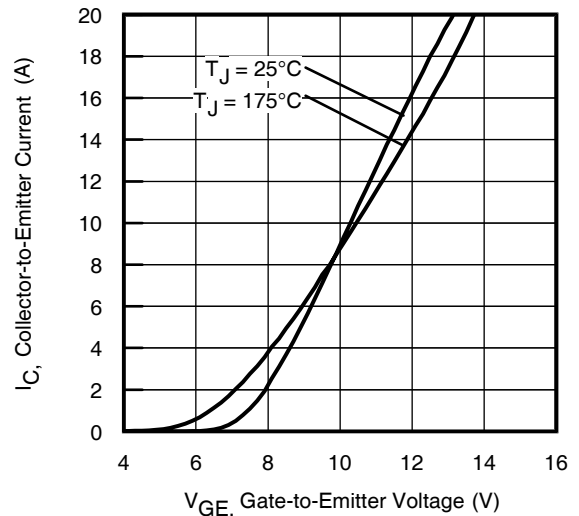

Fig. 12 - Typ. Transfer Characteristics
 $V_{CE} = 50\text{V}$; $t_p = 10\mu\text{s}$

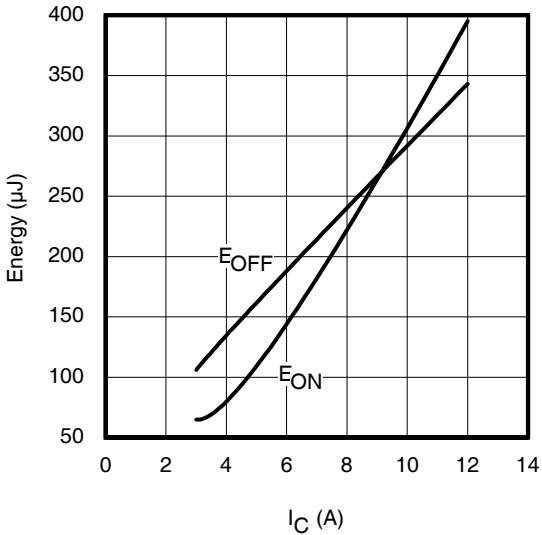

Fig. 13 - Typ. Energy Loss vs. I_C
 $T_J = 175^\circ\text{C}$; $L = 1\text{mH}$; $V_{CE} = 400\text{V}$; $R_G = 47\Omega$; $V_{GE} = 15\text{V}$.

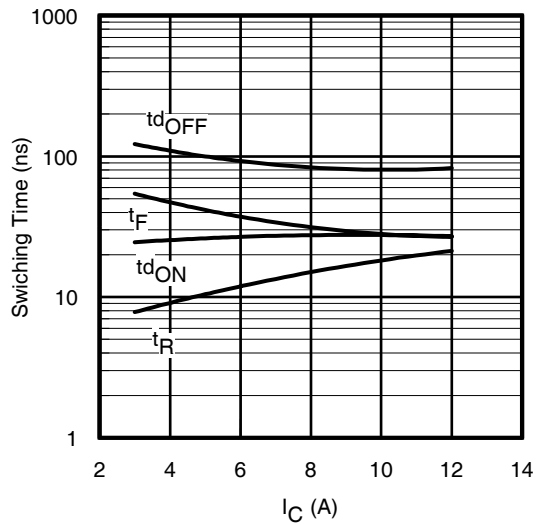

Fig. 14 - Typ. Switching Time vs. I_C
 $T_J = 175^\circ\text{C}$; $L = 1\text{mH}$; $V_{CE} = 400\text{V}$
 $R_G = 47\Omega$; $V_{GE} = 15\text{V}$

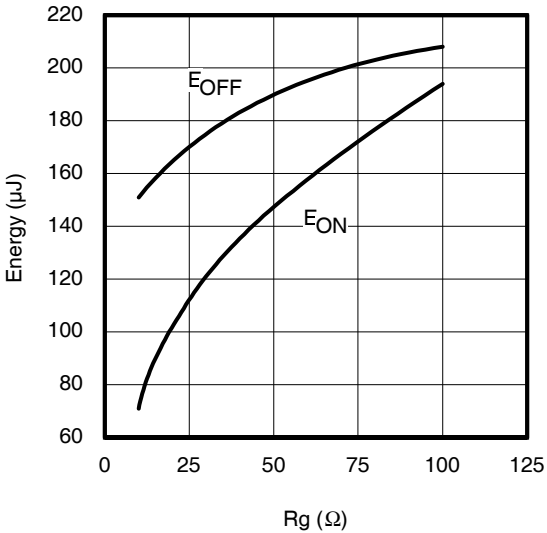

Fig. 15 - Typ. Energy Loss vs. R_G
 $T_J = 175^\circ\text{C}$; $L = 1\text{mH}$; $V_{CE} = 400\text{V}$; $I_{CE} = 6.0\text{A}$; $V_{GE} = 15\text{V}$

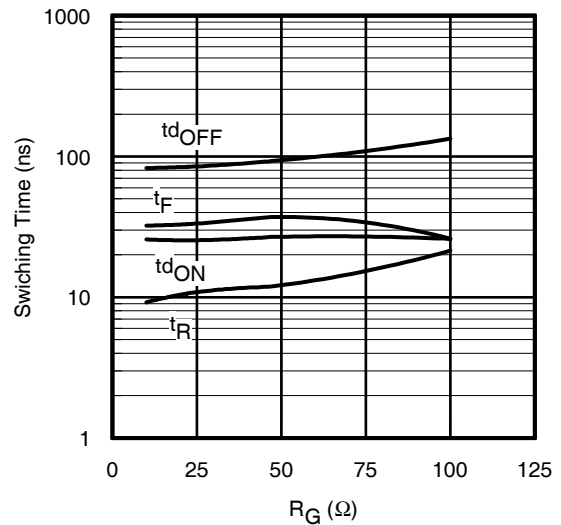

Fig. 16 - Typ. Switching Time vs. R_G
 $T_J = 175^\circ\text{C}$; $L = 1\text{mH}$; $V_{CE} = 400\text{V}$
 $I_{CE} = 6.0\text{A}$; $V_{GE} = 15\text{V}$

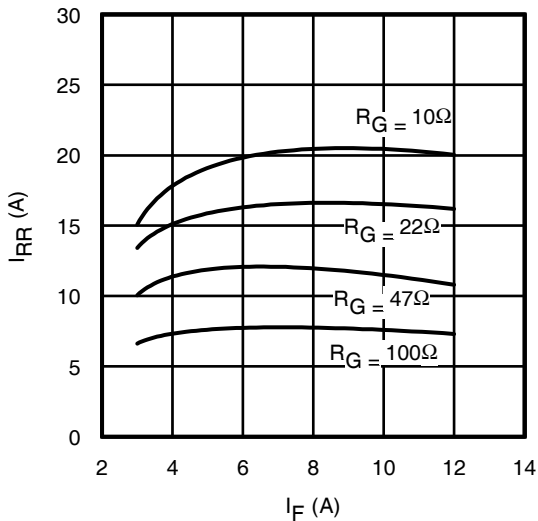

Fig. 17 - Typical Diode I_{RR} vs. I_F
 $T_J = 175^\circ\text{C}$

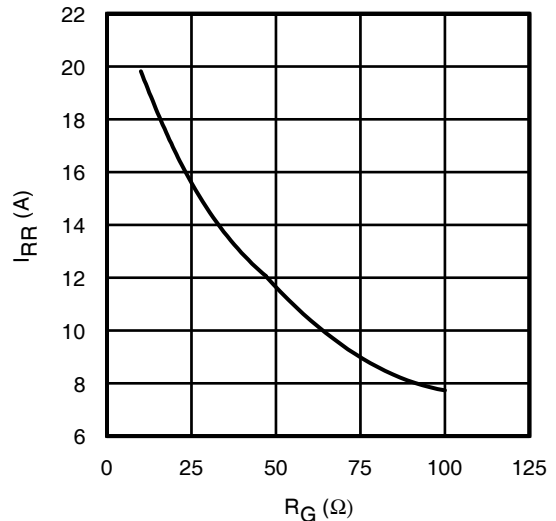

Fig. 18 - Typical Diode I_{RR} vs. R_G
 $T_J = 175^\circ\text{C}$; $I_F = 6.0\text{A}$

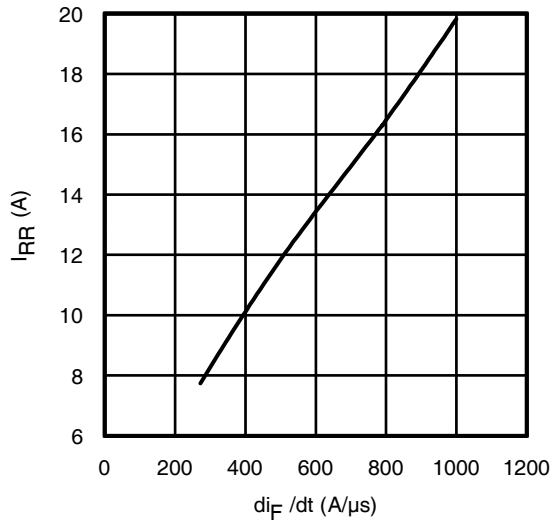

Fig. 19- Typical Diode I_{RR} vs. di_F/dt
 $V_{CC}=400V$; $V_{GE}=15V$;
 $I_{CE}=6.0A$; $T_J=175^\circ C$

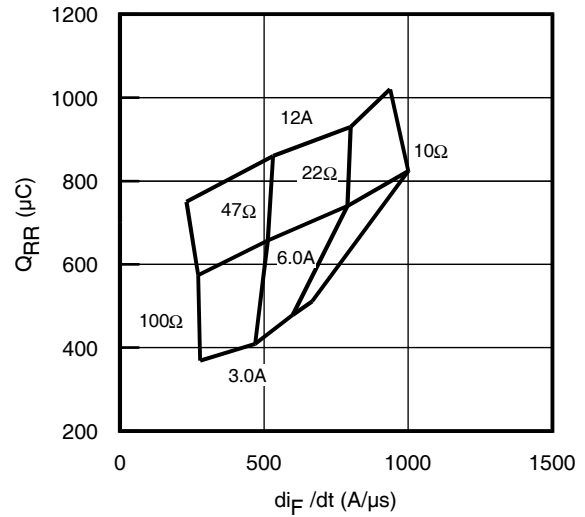

Fig. 20 - Typical Diode Q_{RR}
 $V_{CC}=400V$; $V_{GE}=15V$; $T_J=175^\circ C$

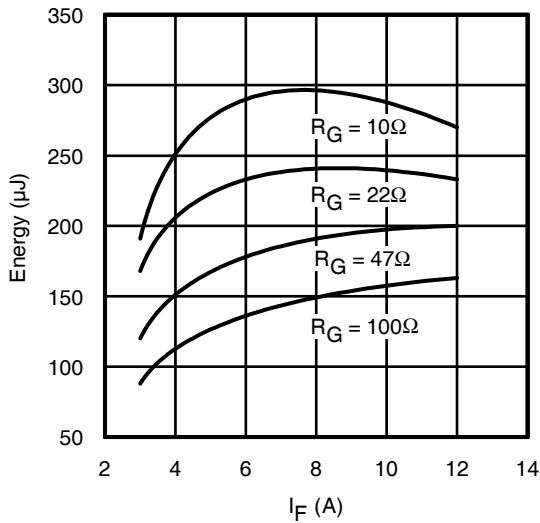

Fig. 21 - Typical Diode E_{RR} vs. I_F
 $T_J=175^\circ C$

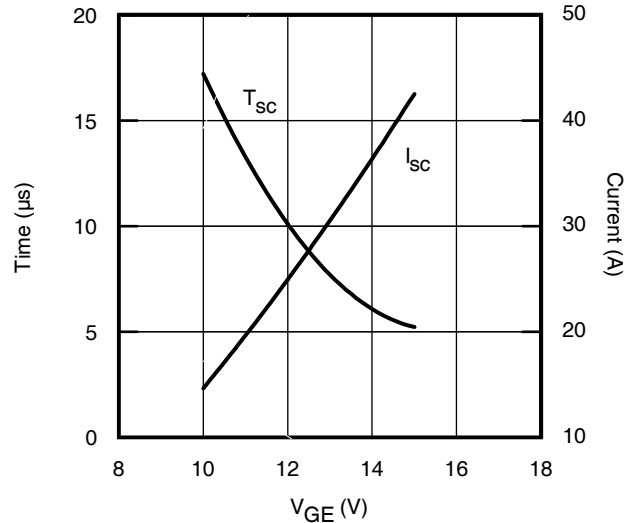

Fig. 22- Typ. V_{GE} vs. Short Circuit Time
 $V_{CC}=400V$, $T_C=25^\circ C$

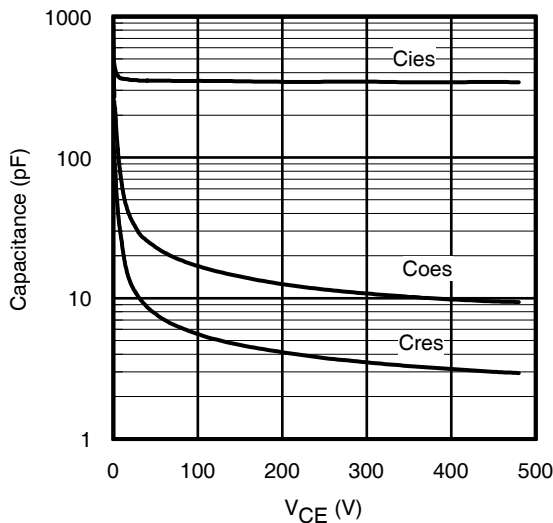

Fig. 23- Typ. Capacitance vs. V_{CE}
 $V_{GE}=0V$; $f=1MHz$

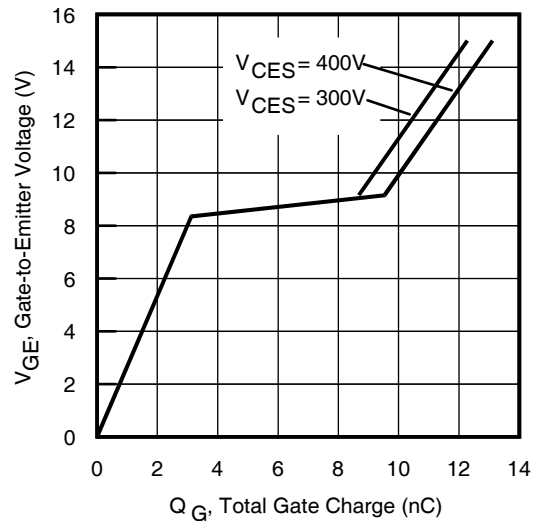

Fig. 24 - Typical Gate Charge vs. V_{GE}
 $I_{CE}=6.0A$, $L=600\mu H$

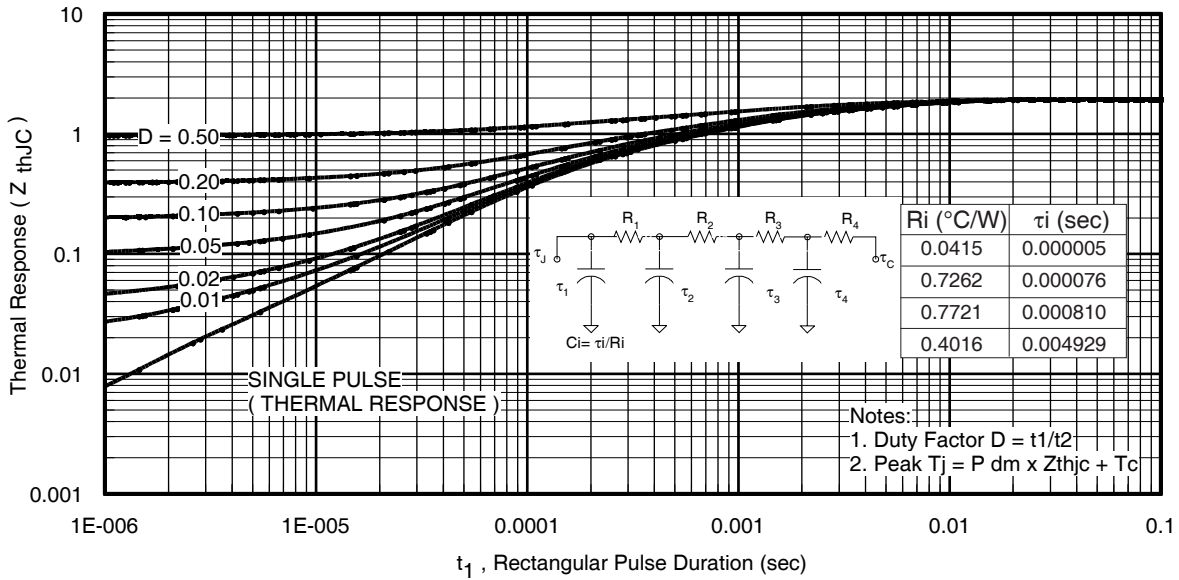

Fig 25. Maximum Transient Thermal Impedance, Junction-to-Case (IGBT)

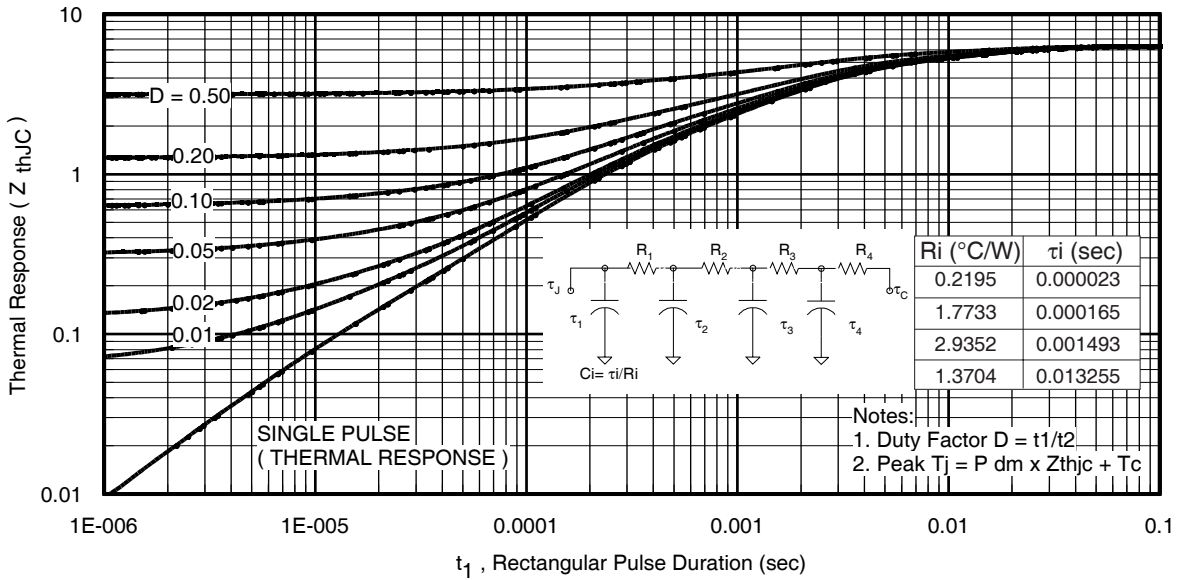

Fig. 26. Maximum Transient Thermal Impedance, Junction-to-Case (DIODE)

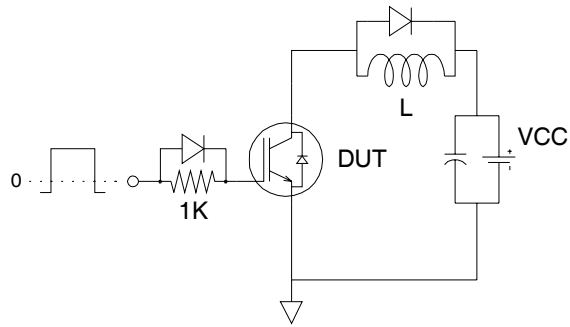

Fig.C.T.1 - Gate Charge Circuit (turn-off)

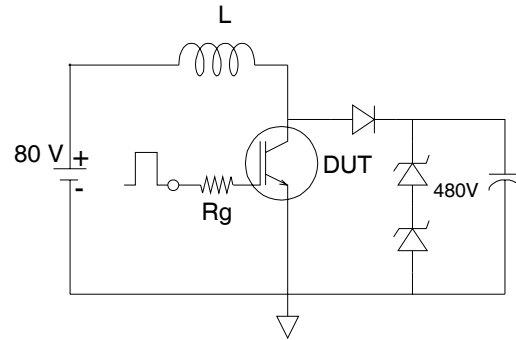

Fig.C.T.2 - RBSOA Circuit

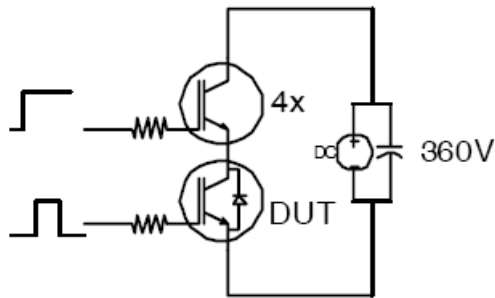

Fig.C.T.3 - S.C.SOA Circuit

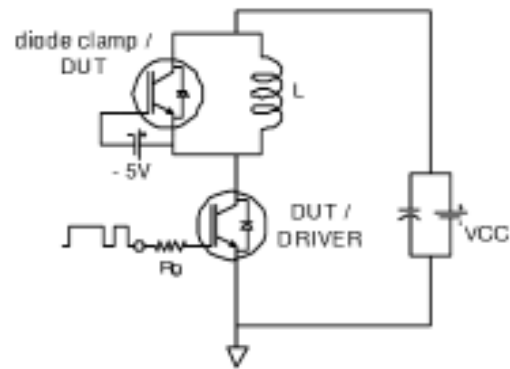

Fig.C.T.4 - Switching Loss Circuit

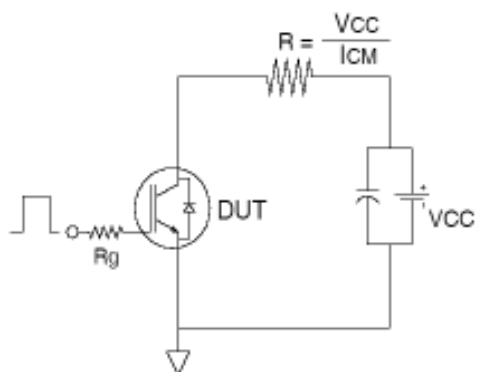

Fig.C.T.5 - Resistive Load Circuit

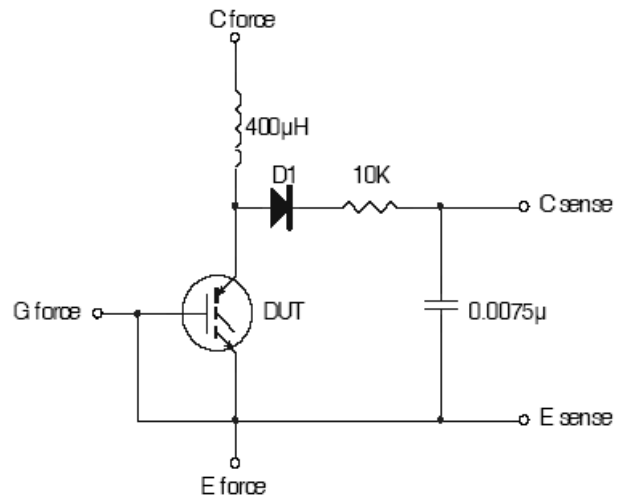

Fig.C.T.6 - Typical Filter Circuit for $V_{(BR)CES}$ Measurement

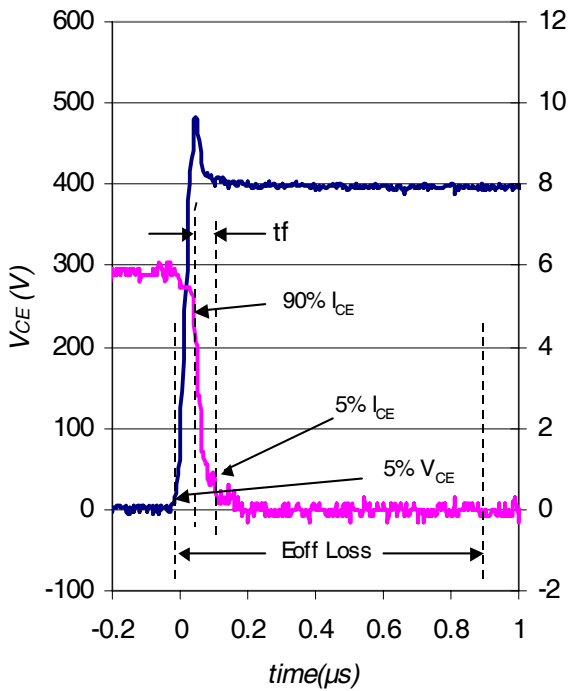

Fig. WF1 - Typ. Turn-off Loss Waveform
@ $T_J = 175^\circ\text{C}$ using Fig. CT.4

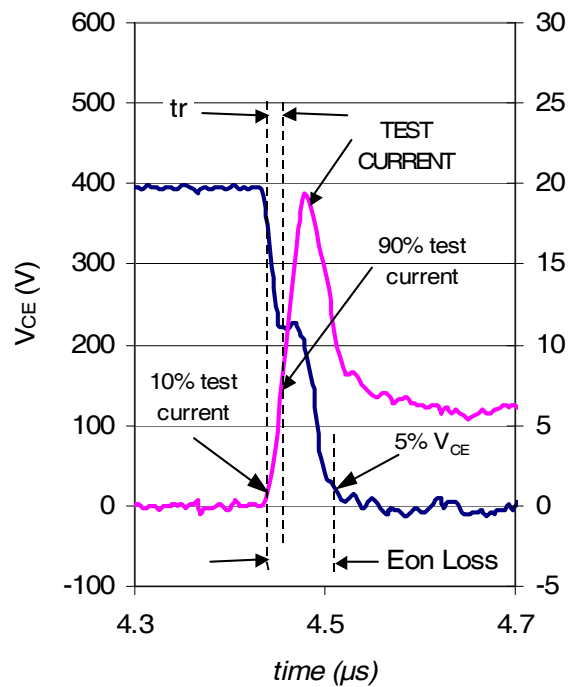
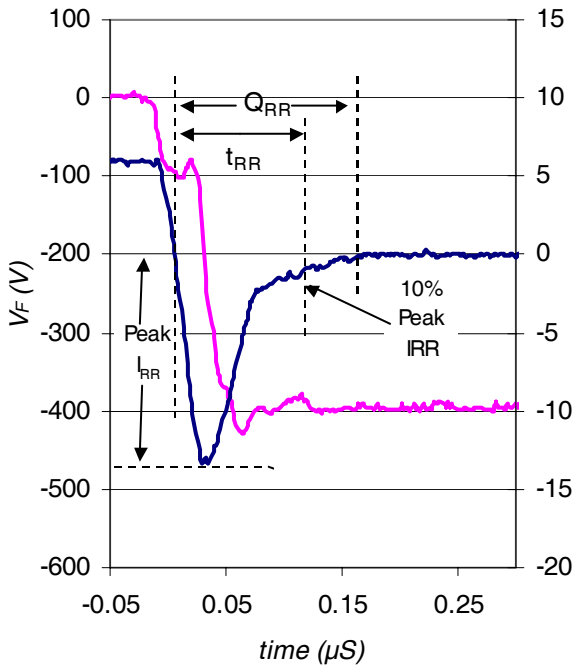
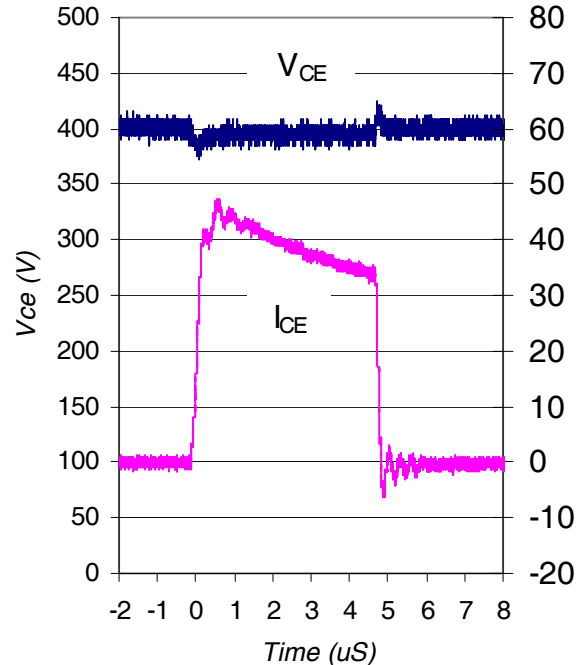

Fig. WF2 - Typ. Turn-on Loss Waveform
@ $T_J = 175^\circ\text{C}$ using Fig. CT.4



WF.3- Typ. Diode Recovery Waveform
@ $T_J = 175^\circ\text{C}$ using CT.4



WF.4- Typ. Short Circuit Waveform
@ $T_J = 25^\circ\text{C}$ using CT.3

TO-220AB Package Outline (Dimensions are shown in millimeters (inches))

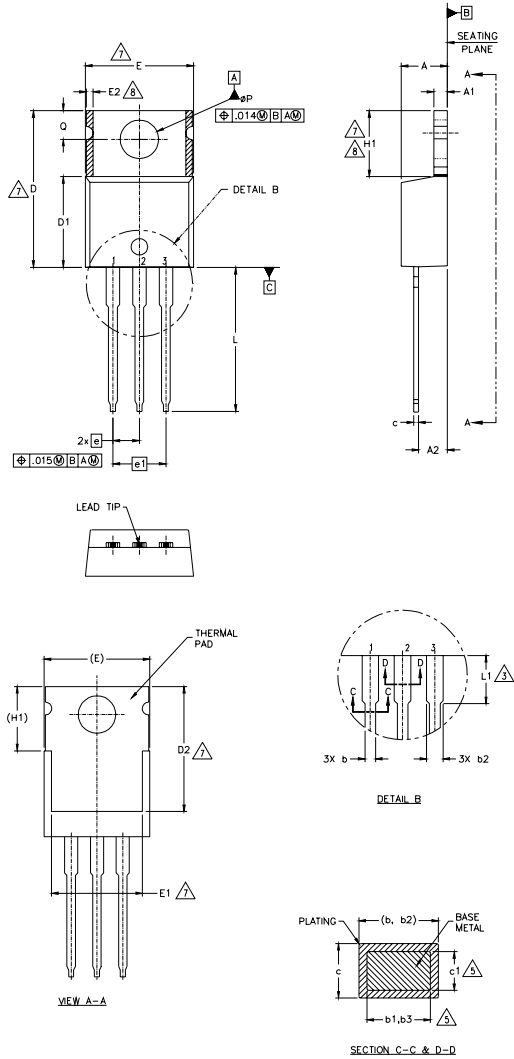

NOTES:

- 1.- DIMENSIONING AND TOLERANCING AS PER ASME Y14.5 M- 1994.
- 2.- DIMENSIONS ARE SHOWN IN INCHES [MILLIMETERS].
- 3.- LEAD DIMENSION AND FINISH UNCONTROLLED IN L1.
- 4.- DIMENSION D, D1 & E DO NOT INCLUDE MOLD FLASH. MOLD FLASH SHALL NOT EXCEED .005" (0.127) PER SIDE. THESE DIMENSIONS ARE MEASURED AT THE OUTERMOST EXTREMES OF THE PLASTIC BODY.
- 5.- DIMENSION b1, b3 & c1 APPLY TO BASE METAL ONLY.
- 6.- CONTROLLING DIMENSION : INCHES.
- 7.- THERMAL PAD CONTOUR OPTIONAL WITHIN DIMENSIONS E,H1,D2 & E1
- 8.- DIMENSION E2 X H1 DEFINE A ZONE WHERE STAMPING AND SINGULATION IRREGULARITIES ARE ALLOWED.
- 9.- OUTLINE CONFORMS TO JEDEC TO-220, EXCEPT A2 (max.) AND D2 (min.) WHERE DIMENSIONS ARE DERIVED FROM THE ACTUAL PACKAGE OUTLINE.

SYMBOL	DIMENSIONS				NOTES
	MILLIMETERS		INCHES		
	MIN.	MAX.	MIN.	MAX.	
A	3.56	4.83	.140	.190	
A1	0.51	1.40	.020	.055	
A2	2.03	2.92	.080	.115	
b	0.38	1.01	.015	.040	
b1	0.38	0.97	.015	.038	5
b2	1.14	1.78	.045	.070	
b3	1.14	1.73	.045	.068	5
c	0.36	0.61	.014	.024	
c1	0.36	0.56	.014	.022	5
D	14.22	16.51	.560	.650	4
D1	8.38	9.02	.330	.355	
D2	11.68	12.88	.460	.507	7
E	9.65	10.67	.380	.420	4,7
E1	6.86	8.89	.270	.350	7
E2	-	0.76	-	.030	8
e	2.54 BSC		.100 BSC		
e1	5.08 BSC		.200 BSC		
H1	5.84	6.86	.230	.270	7,8
L	12.70	14.73	.500	.580	
L1	-	6.35	-	.250	3
ØP	3.54	4.08	.139	.161	
Q	2.54	3.42	.100	.135	

LEAD ASSIGNMENTS

HEXFET

- 1.- GATE
- 2.- DRAIN
- 3.- SOURCE

IGBTs, CoPACK

- 1.- GATE
- 2.- COLLECTOR
- 3.- EMITTER

DIODES

- 1.- ANODE/OPEN
- 2.- CATHODE
- 3.- ANODE

TO-220AB Part Marking Information

EXAMPLE: THIS IS AN IRF1010
LOT CODE 1789
ASSEMBLED ON WW 19, 2000
IN THE ASSEMBLY LINE "C"

Note: "P" in assembly line position indicates "Lead - Free"

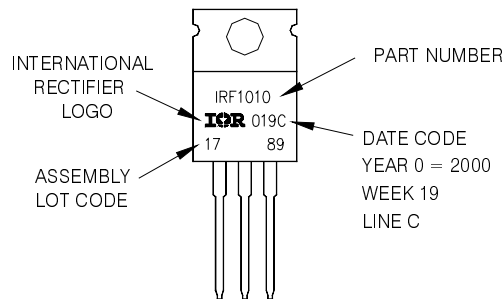

TO-220AB packages are not recommended for Surface Mount Application.

Data and specifications subject to change without notice.
This product has been designed and qualified for Industrial market.
Qualification Standards can be found on IR's Web site.